

PRODUCTS SPECIFICATION

5050 SMD RIGID BAR SERIES

For LD-RD-A5050-12-48

Made by	Checked by	Version
Mustafa	Lucy	2009.2.4

CE ~~Pb~~ ROHS IP67

48 LED Rigid bar introduction.

Features:

Available in DC12V maximum.

Very bright & low power consumption.

Operating temperature: -20~50C°.

Long life span LED lights, more than 50,000 hours +.

Dimmable to 6V DC.

Water-proof, IP67.

Photos:

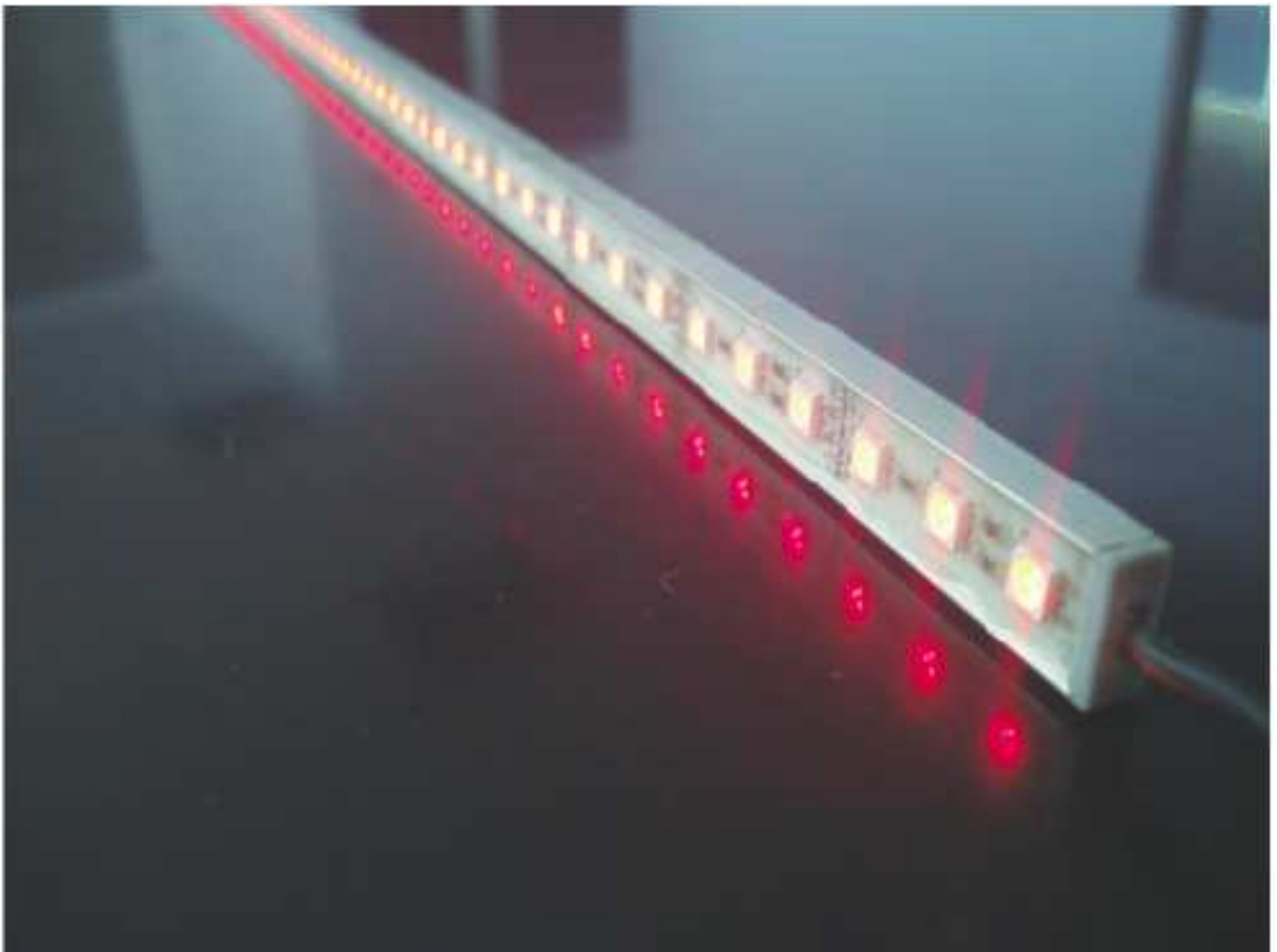

Assembly drawing

Top View

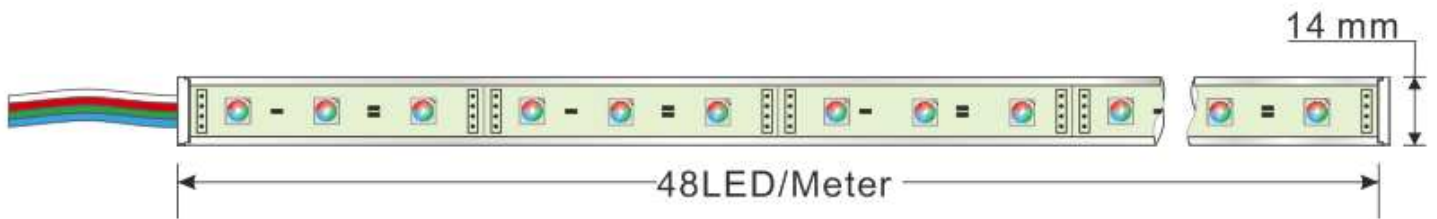

Section



3D View



View Angle: 120degrees







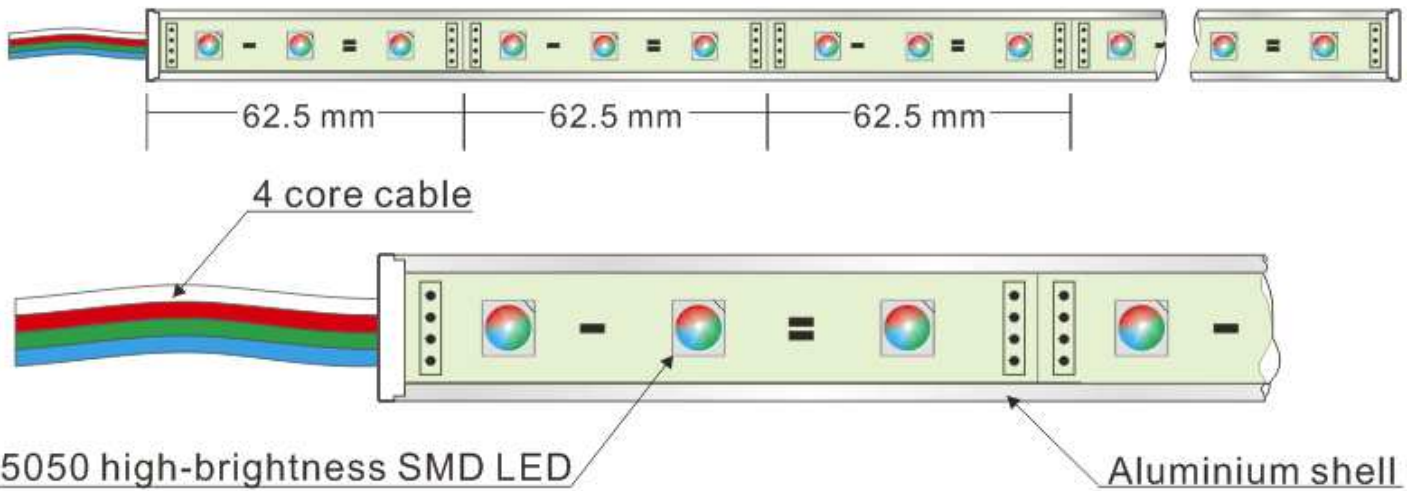



Operation Temperature: -20°C~50°C

Store Temperature: -30°C~80°C

5050 SMD LED Rigid bar: 48 LED/meter



These strips are widely used in shop and bar illumination, it works at 12DC, with super bright SMD LEDs, wide view angle, compact size, easy to install, Aluminium PCB holder help you to fix easily. Water-proof, long life span (more than 50000 hours),

Aluminium series : 5050 48LED/meter						
Part number	Color	Size	LED QTY/meter	Lumen/meter	Voltage	Power/meter
LD-RD-A5050RGB-12-48	Red 	62.5 mm	48	96	DC12V	11.52 watt
	Green 	62.5 mm		192		
	Blue 	62.5 mm		120		
LD-RD-A5050R-12-48	Red 	62.5 mm	48	288	DC12V	11.52 watt
LD-RD-A5050Y-12-48	Yellow 	62.5 mm	48	288	DC12V	11.52 watt
LD-RD-A5050B-12-48	Blue 	62.5 mm	48	360	DC12V	11.52 watt
LD-RD-A5050G-12-48	Green 	62.5 mm	48	576	DC12V	11.52 watt
LD-RD-A5050W-12-48	White 	62.5 mm	48	720~936	DC12V	11.52 watt
LD-RD-A5050WW-12-48	Warm white 	62.5 mm	48	576~864	DC12V	11.52 watt
LD-RD-A5050P-12-48	Pink 	62.5 mm	48	288	DC12V	11.52 watt

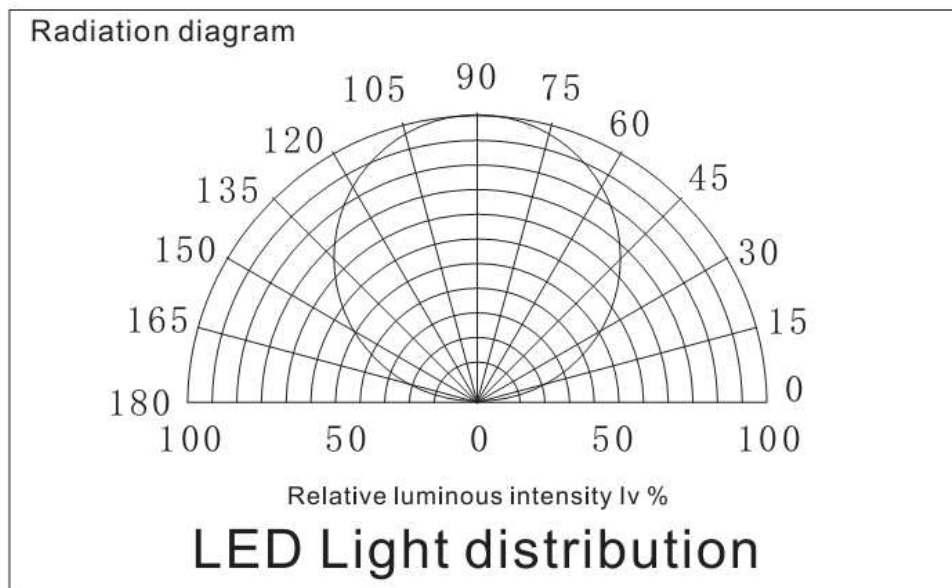

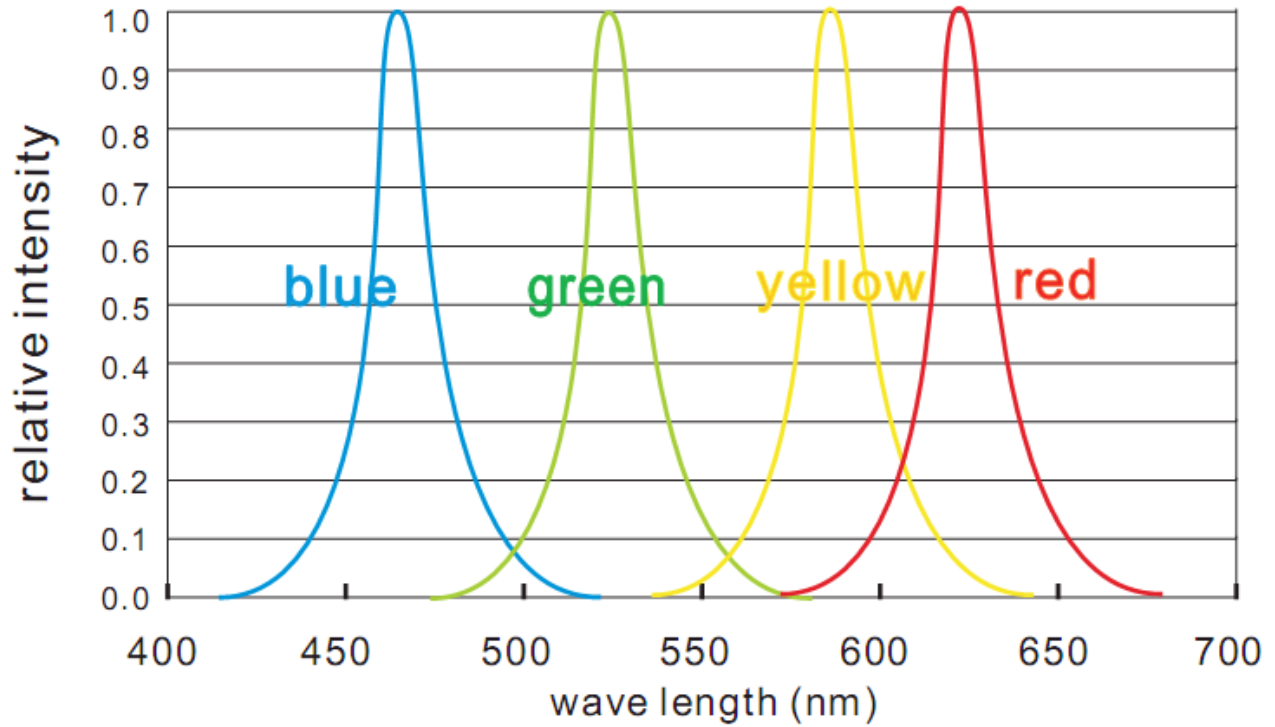

for: red, blue, green, yellow

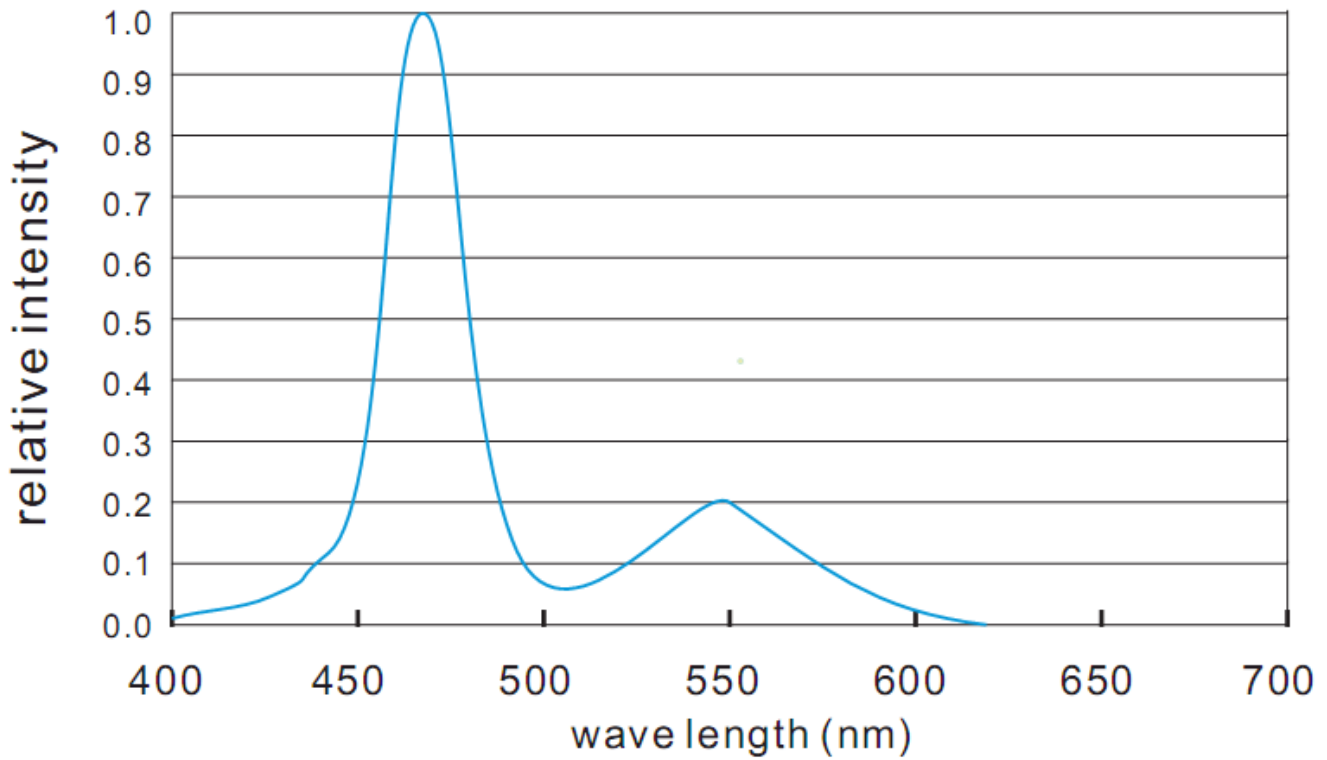

for: white LED

How to connect rigid bar.

Below shows you how to connect the Rigid bar to power supplies.

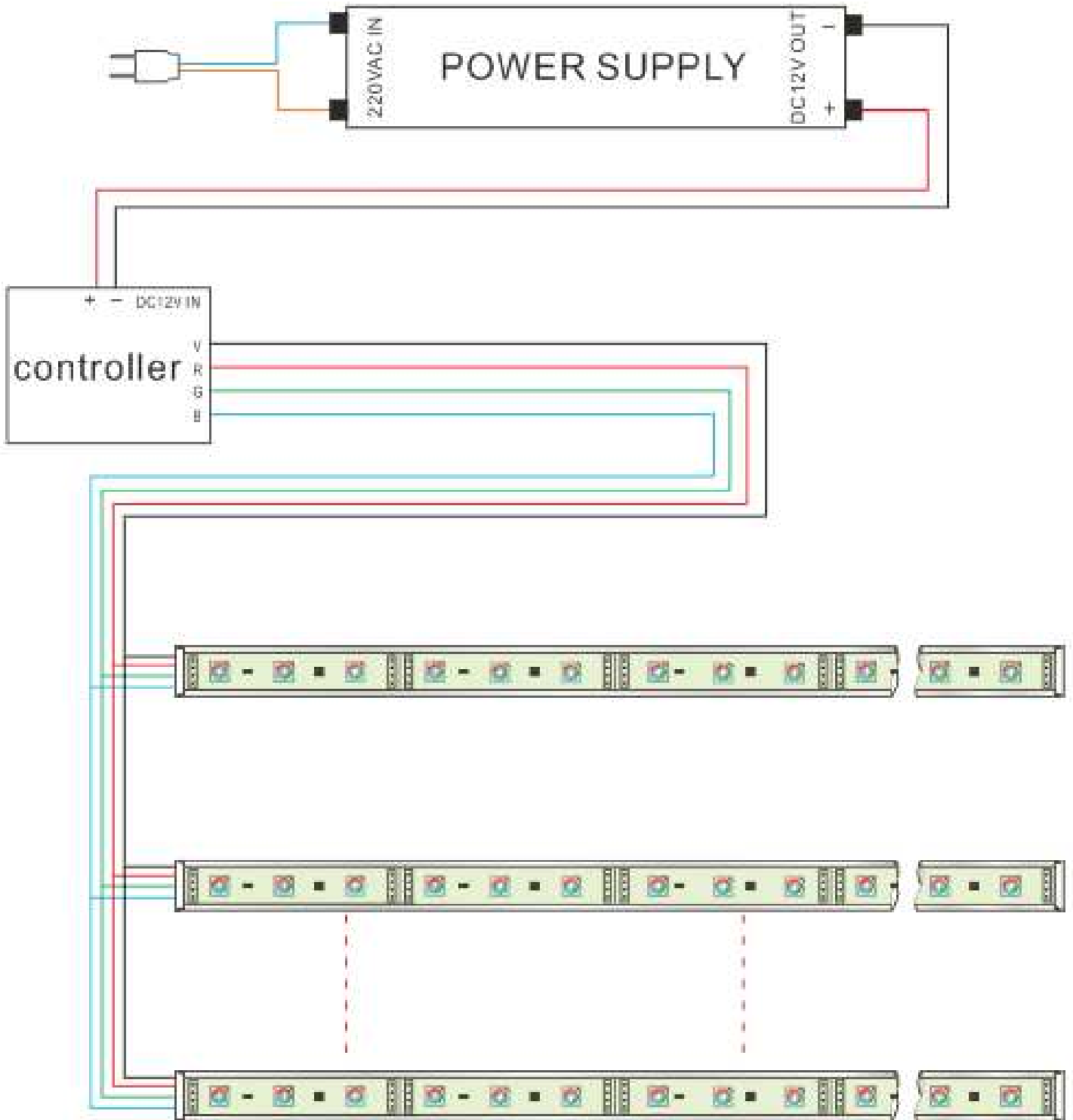

How to connect single color rigid bar.

Below shows you how to connect the single color rigid bar to power supplies.

