

PRODUCTS SPECIFICATION

5050 SMD RIGID BAR SERIES

For LD-RD-A5050-12-60

Made by	Checked by	Version
Mustafa	Lucy	2009.2.4



# 60 LED Rigid bar introduction.

## Features:

Available in DC12V maximum.

Very bright & low power consumption.

Operating temperature: -20~50C°.

Long life span LED lights, more than 50,000 hours +.

Dimmable to 6V DC.

Water-proof, IP67.

## Photos:

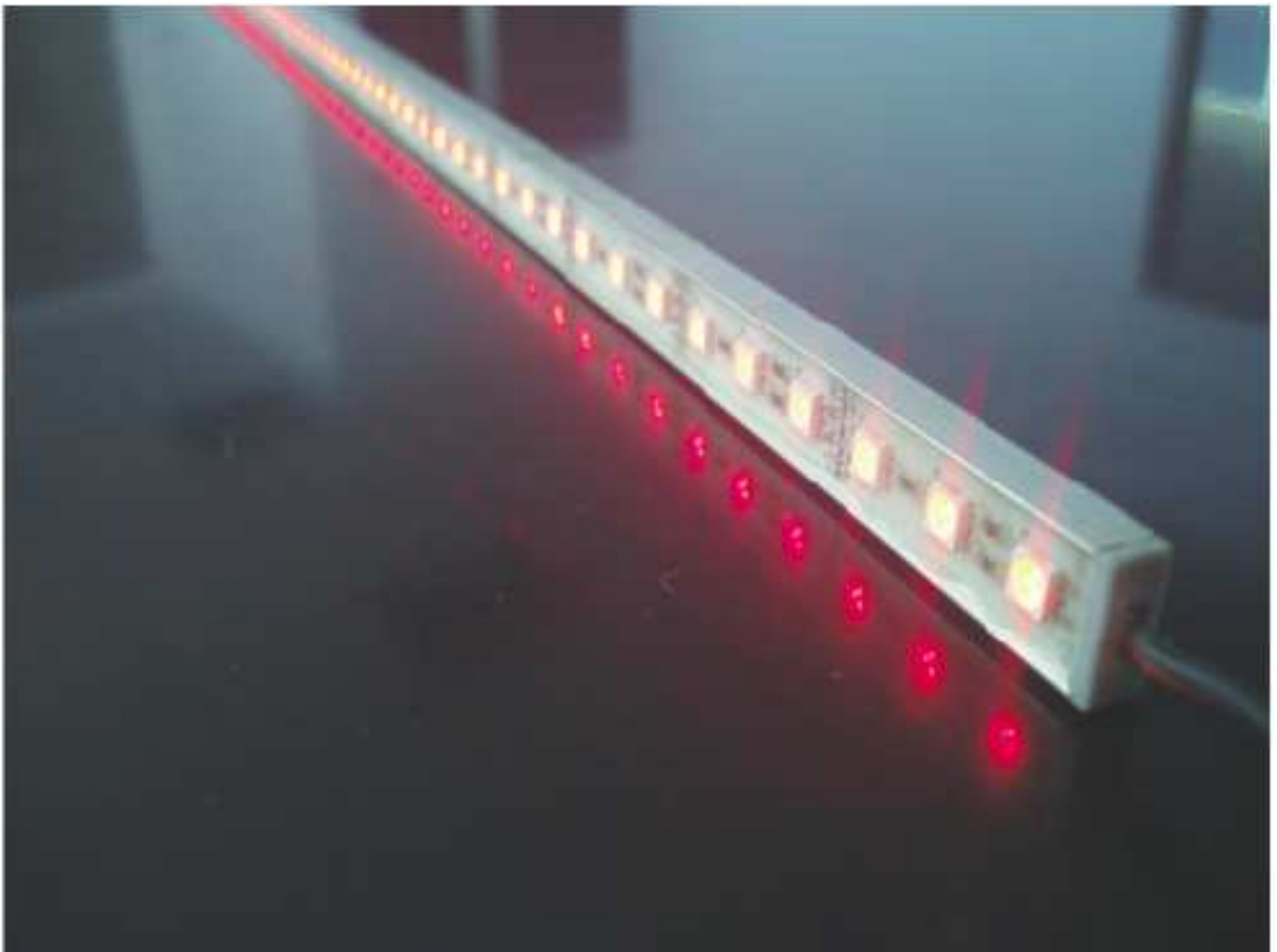

# Assembly drawing

## Top View

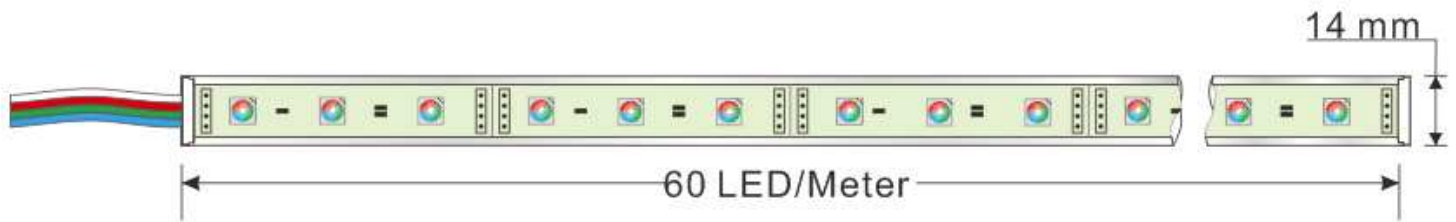

## Section



## 3D View

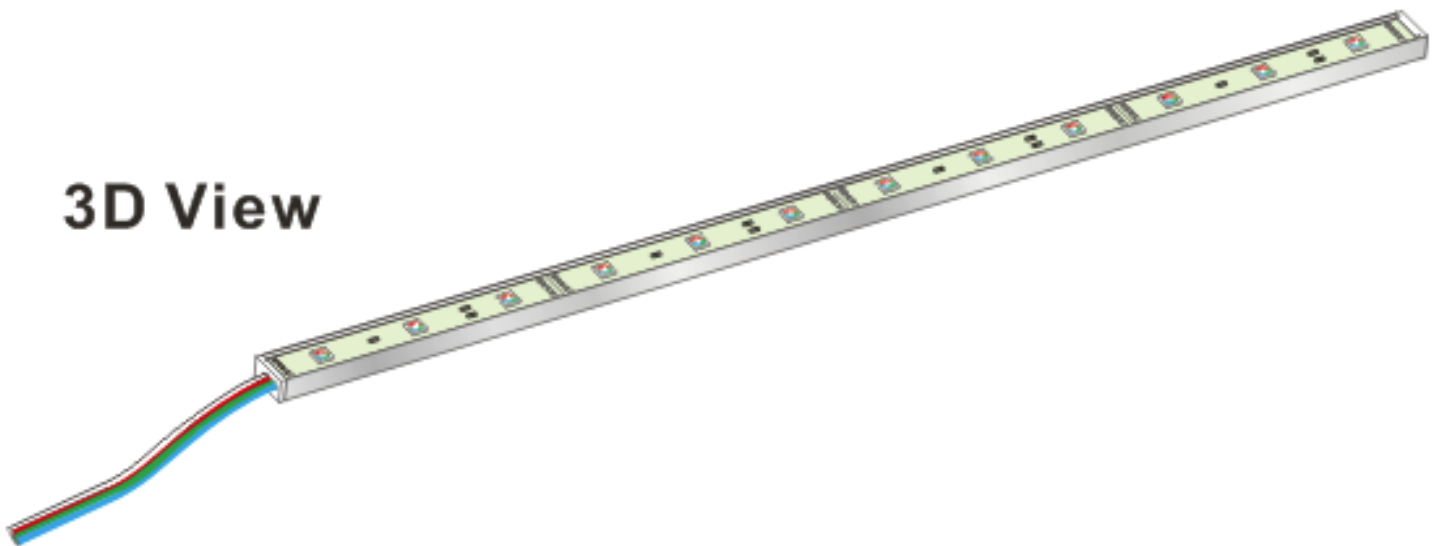

**View Angle: 120degrees**

**Operation Temperature: -20°C~50°C**

**Store Temperature: -30°C~80°C**

# 5050 SMD LED Rigid bar: 60 LED/meter

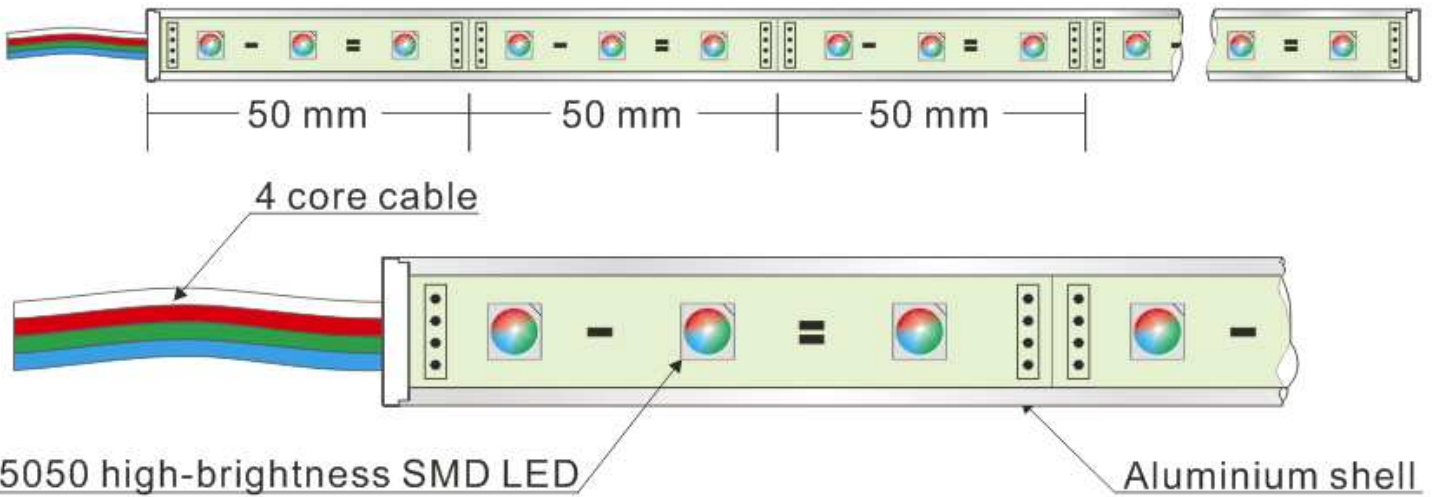

These strips are widely used in shop and bar illumination, it works at 12DC, with super bright SMD LEDs, wide view angle, compact size, easy to install, Aluminium PCB holder help you to fix easily. Water-proof, long life span (more than 50000 hours),

Aluminium series: 5050 60LED/meter						
Part number	Color	Size	LED QTY/meter	Lumen/meter	Voltage	Power/meter
LD-RD-A5050RGB-12-60	Red	100mm	60	120	DC12 V	14.4 watt
	Green	100mm		240		
	Blue	100mm		150		
LD-RD-A5050R-12-60	Red	100mm	60	360	DC12 V	14.4 watt
LD-RD-A5050Y-12-60	Yellow	100mm	60	360	DC12 V	14.4 watt
LD-RD-A5050B-12-60	Blue	100mm	60	450	DC12 V	14.4 watt
LD-RD-A5050G-12-60	Green	100mm	60	720	DC12 V	14.4 watt
LD-RD-A5050W-12-60	White	100mm	60	900	DC12 V	14.4 watt
LD-RD-A5050WW-12-60	Warm white	100mm	60	720	DC12 V	14.4 watt
LD-RD-A5050P-12-60	Pink	100mm	60	360	DC12 V	14.4 watt

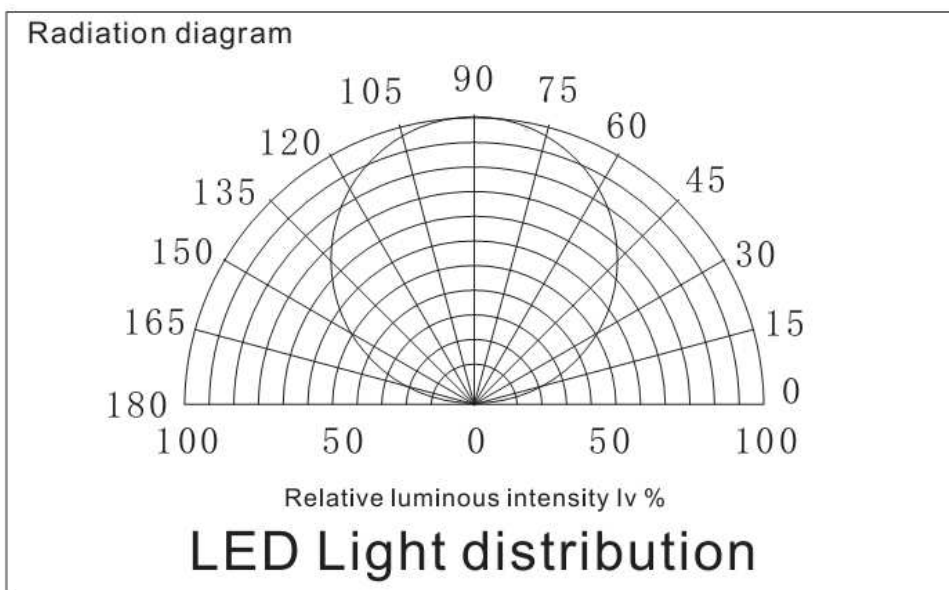

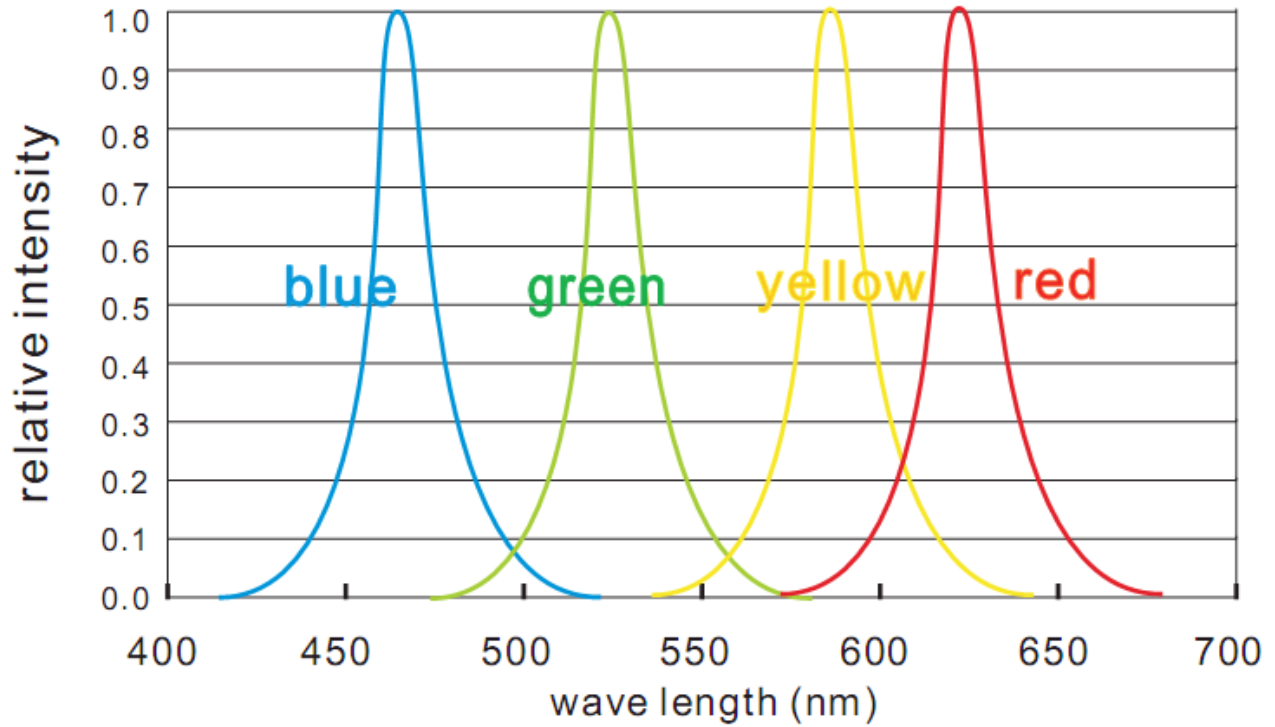

for: red, blue, green, yellow

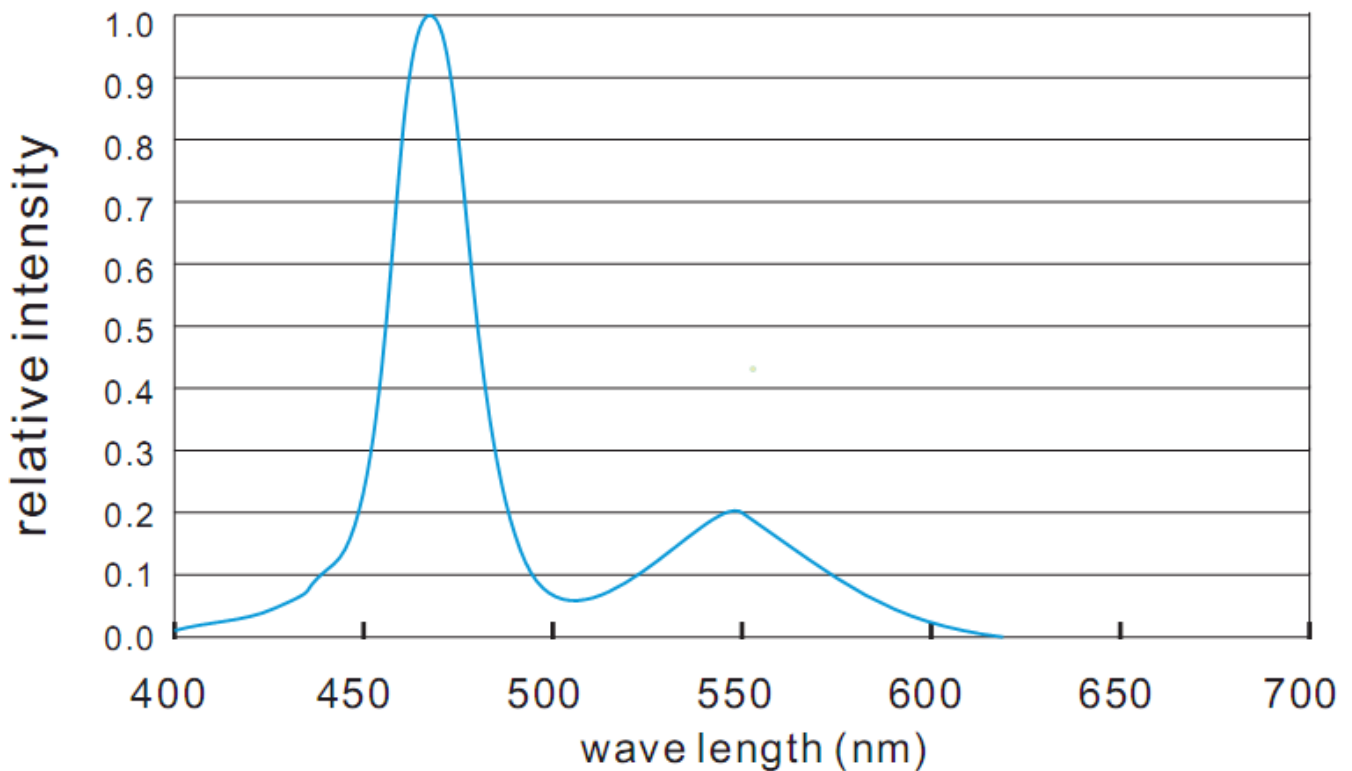

for: white LED

## How to connect RGB rigid bar.

Below shows you how to connect the RGB rigid bar to power supplies.

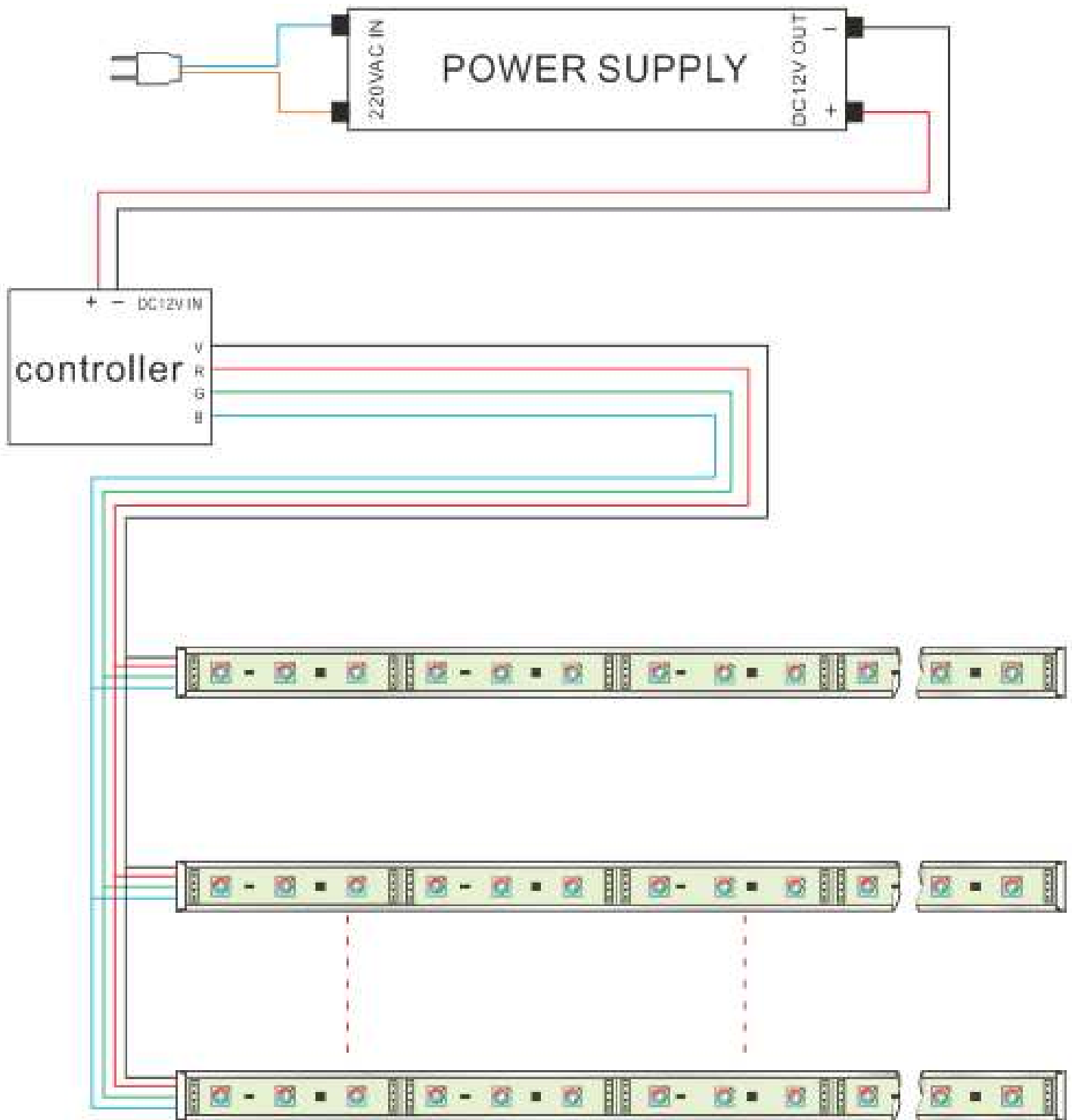

## How to connect single color rigid bar.

Below shows you how to connect the single color rigid bar to power supplies.

